

A person is shown in profile, focused on installing carpet tiles. They are holding a dark-colored tile and aligning it with others already laid on the floor. The room is dimly lit, with a bright skylight in the background creating a strong contrast and casting long shadows. The overall mood is professional and precise.

Installation Guide

Interface®

Contents

Click to Continue

To Note	3
Preparation	4-5
Planning	6-9
Carpet Tile Installation	10-12
Skinny Plank Installation	13-14
Acoustic & Comfort Backing	15
Interlay	16-18
Queries	19

To Note

Carpet Tiles

1. In order to minimise the possible effects of shading, Interface products are dispatched in dye batches, which may be readily identified on all products and should not be mixed, unless stated otherwise. It is the responsibility of the contractor, or those signing on their behalf, to check the delivery for quantity and dye batching prior to accepting and signing the delivery note.

NB: On all installations there is a maximum benchmark area of 100m² which should be inspected by all authorising parties. Should there be any discrepancies against original specification or manufacturing, Interface should be notified prior to the continuation of the remaining installation.

2. Textile floorcoverings, especially cut pile products, can be susceptible to temporary pressure marking – an effect caused by packing, storage and shipment. This temporary effect occurs with all grades of carpet and will vanish as the tufts recover and the carpet regains its original appearance.
3. Any variation in site practices to those stated in this guide may have the effect of rendering the guarantee invalid. Interface cannot accept responsibility for faults occurring as a result of methods of installation varying from those outlined in this guide. These instructions should also be read in conjunction with the Interface conditions of sale.
4. Health & Safety. Adhesives and floor preparation materials must be used in accordance with manufacturers' recommended procedures or precautions regarding safe handling procedures. COSHH and H&S data sheets need to be obtained from the appropriate adhesive manufacturer.

Additional Information – Rugs

Take care when cleaning the surrounding hard floors so as not to cause damage at the rug edges. Heavy duty brushing machines could cause damage to the pile at the edges or dislodge tiles if coming in to contact with them. Also ensure that any polish or wax finish is thoroughly cleaned so as not to transfer on to the surface of the rug.

Preparation

1. Conditioning of Materials

Due to the nature of textile materials, they need to be acclimatised to the atmospheric conditions that will prevail after installation and during use. Carpet tiles from Interface should be unpacked and allowed to condition in an area having a minimum temperature of 16°C for at least 24 hours before laying.

NB: Products with Circuitbac Green backing.

Although conditioning prior to installation is important for all products it is crucial for products with Circuitbac Green backing. Products must be left in the box and conditioned for at least 24 hours in an area with a minimum room temperature of 16°C before laying to avoid any issues with regards to the handle and stability of the product.

2. Site Conditions

2.1 Floor Preparation

Before starting to lay Interface carpet tiles, the position and depth of cables, heating elements and water pipes in the floor screed should be ascertained and all preliminary work, such as the fixing of floor sockets for service plugs, should be complete. The base should be firm, smooth and dry and floors should be cleared of all debris and free from defects. All traces of old floorcoverings and adhesive residues must be removed and, if necessary, the surface treated with Stoppap by F. Ball & Co. Ltd, or an equivalent floor smoothing underlayment (see *Figure 1*) to suit local site conditions in accordance with manufacturers recommendations.

Any necessary preparation should be carried out in good time, to allow for setting and drying of any smoothing underlayment.

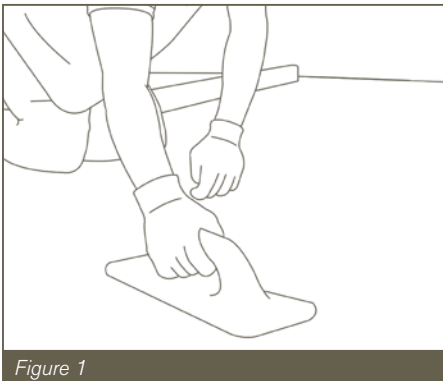

Figure 1

2.2 Damp Proofing

An efficient damp proof membrane should be incorporated in the construction of solid floors at ground or below ground level, or where moisture ingress may become apparent.

Additional Information – Rugs

The subfloor should be firm, level and dry and cleared of all debris. Interface carpet tiles can be laid over a variety of surfaces such as ceramic, hardwood and stone. Please ensure that such surfaces are thoroughly cleaned to remove all traces of possible contamination such as grease or wax polish. Use water or proprietary degreasing agents in accordance with Manufacturers recommendations.

Carpet tiles should not be laid over soft surfaces including existing carpet. However a rug design may be inserted within an existing carpet tile installation. In such cases ensure all traces of old floor coverings and adhesive residues are removed completely.

All subfloors should be prepared in accordance with BS 5325 or corresponding national and European standards.

Preparation

2.3 Subfloors

Subfloors should be prepared in accordance with BS 5325 or corresponding national and European standards. The suitability of a particular smoothing underlayment will depend upon the subfloor type and other requirements, e.g. high impact resistance.

2.3.1 Concrete

New concrete should be fully cured and sealed. Humidity must not exceed 75% (Hygrometer Test). Old concrete should be smooth and level. Resealing is recommended if chemicals have been used to remove a previous finish or where dusting is evident.

2.3.2 Timber

The floor should be structurally sound, level, smooth, dry and clean. Worn or uneven floorboards should either be replaced or levelled by sanding, planing or patch filling before covering with flooring grade plywood, chipboard or hardboard (rough side facing upwards) and pinned at 100 mm centres (see Figure 2, BS 5325 & BS 8203 for further details).

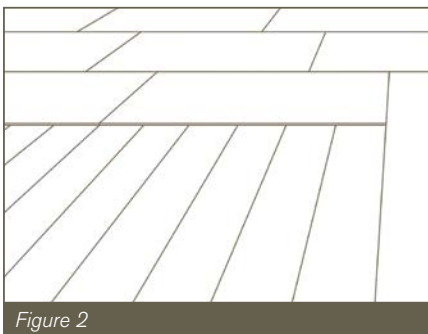

Figure 2

2.3.3 Wood Block Floors

Providing these are smooth, sound, level and securely bonded, they should be overlaid with flooring grade plywood, chipboard or hardboard as above. Wood blocks on ground floors must include an efficient damp proof membrane. If these conditions cannot be met the wood blocks must be removed and the subfloor prepared accordingly.

2.3.4 Chipboard

Chipboard should comply to EN 312 and be free from wax, polyurethane or other types of surface seal. Uneven floors should be treated as described for timber floors.

2.3.5 Terrazzo, Marble etc.

All cracks and irregularities should be patched and any chemical finishes removed. Grout lines must be filled with a suitable levelling compound. If there is any doubt about moisture ingress, cover with a layer of floor grade asphalt followed by skimming with 3 mm smoothing underlayment.

2.3.6 Asphalt

Asphalt should be flooring grade and comply with the requirements of BS 8204. Providing it is in good condition, sound, strong then the surface should be cleaned before a smoothing underlayment is applied.

NB: PVC products should not be installed directly onto asphalt floors. Such floors would have to be screeded prior to installation

2.3.7 Raised Access Panels

These should be smooth, level, clean and dry.

2.4 Underfloor Heating

Interface carpet tiles may be installed on internally heated floors, provided that the surface temperature will not exceed 27°C (80°F). Underfloor heating must be turned off at least 48 hours prior to installation.

Planning

3.1 Tools

Steel measuring tape, chalk line, carpet knife and a straight edge. For Skinny Planks a 1 metre set square.

Additional Information – Rugs

Use steel measuring tape, carpet knife and a straight edge.

3.2 Measurement

Determine the centre of the room and starting (or datum) point using standard tile-laying methods. (see *Figure 3*). The resulting quadrants should meet at right angles. Offsetting the centre chalk line may be necessary to ensure that the perimeter tiles will be at least half-size or larger. In some cases, due to doorways or partitions, the starting point is not the centre of the room.

Skinny Planks – Herringbone

For Skinny Planks, particularly when laying traditional herringbone, measurement accuracy is vital to a successful installation.

When deciding on the starting point for herringbone and the pattern direction we recommend consideration of the following key factors:

- The longest dimension of the room.
- The pattern running to the major architectural features e.g. main entrance or reception desk.

See [page 13](#) for more specific advice for planning & installing Skinny Planks.

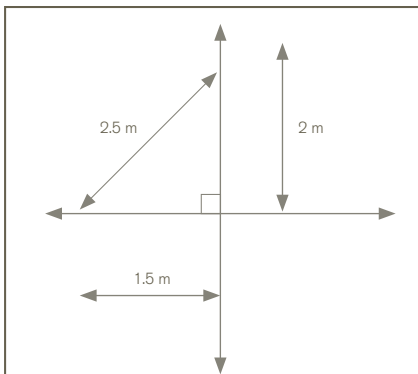

Figure 3

Additional Information – Rugs

Determine the positioning of the rug for the room and use as the starting point.

Each rug will come with a design plan detailing the positioning of the tiles to achieve the desired result. Use the design plans and dry lay the tiles in the correct sequence. This may involve cutting some tiles for the perimeter. The tiles are now ready to connect together so the rug is completed.

Planning

3.3 Method of Fixing

3.3.1 TacTiles®

Interface flooring tiles may be secured using TacTiles.

Subfloor preparation requirements for installations using TacTiles are the same as those for installations where adhesives would be used.

To apply TacTiles see Figures 4, 5 & 6 paying particular attention to the guide marks on each TacTile:



Figure 4



Figure 5



Figure 6

3.3.1.2 TacTiles Placement

Insert tiles based upon the approved installation method. TacTiles should be placed as in Figures 7 & 8.

Quarter Turn, Monolithic and Non-Directional Installation

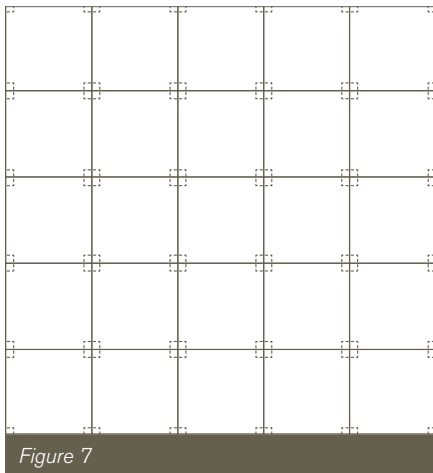

Figure 7

Brick and Ashlar Installation

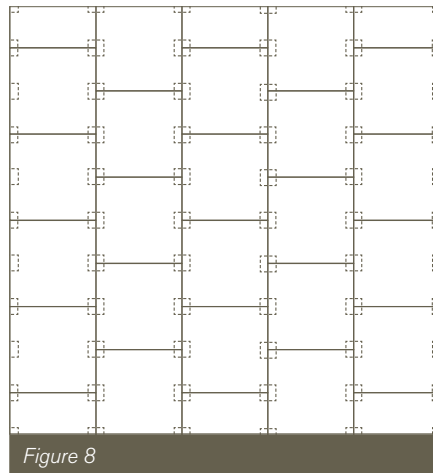

Figure 8

Lay anchor rows, placing a TacTiles connector at every joint. Install carpet tile using a step method in all quadrants, placing a TacTiles connector at every joint.

TacTiles should be applied at all room perimeters. TacTiles must also be applied under every cut tile and any tile adjoining to the cut tile.

NB: Heavy foot traffic may require the use of a higher application rate

Planning

Additional Information – Rugs

TacTiles should be used to join tiles together. One TacTile should be used where four tile corners meet across the entire rug. However, at the perimeter, and possibly the penultimate row, an increased number of TacTiles should be used to reinforce the rug. At each corner at least one additional TacTile should be used along each tile side (See Figure 9).

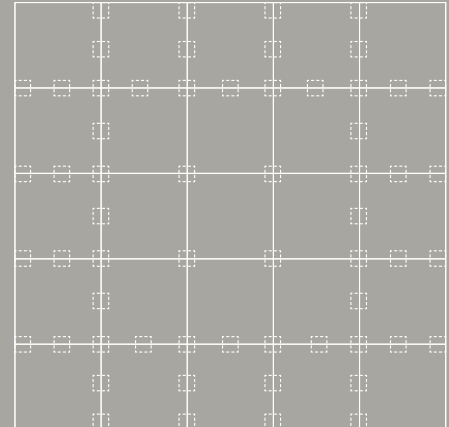

Figure 9

3.3.1.3 Tile Replacement

When uplifting or replacing a carpet tile either lift the carpet tile and peel it from the connector or cut through the TacTiles joining the tiles together. Replace with a new one.

NB: TacTiles are not recommended for installation of carpet tiles on stairs, ramps, in spaces with heavy rolling loads or over existing carpet surfaces.

3.3.2 Adhesive

PVC and Graphflex® backed products are designed for installation using spray adhesive (for example S920 from F. Ball & Co. Ltd) or free-lay installation within a 2 metre stabilisation grid (see Figure 10).

For this grid, an approved tackifier release adhesive must be used and applied using a roller. Where specific national building regulations exist for installation of carpet tiles, these regulations must be applied. Tackifier adhesive should be applied in a 100 mm band width in a 2 metre grid and allowed to dry fully, following the manufacturer's instructions.

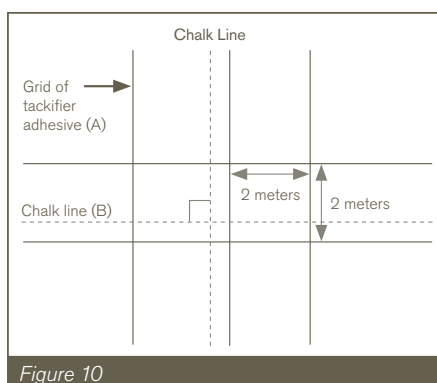

Figure 10

Planning

Recommended Adhesives

Subfloor Type	Double-sided Tape	Spray System (F. Ball & Co. Ltd)	Tackifier Grid (F. Ball & Co. Ltd)	Vertical Surfaces (F. Ball & Co. Ltd)
Concrete	Approved Acrylic	S920	F.41	F.60
Timber & Particle Board	Approved Acrylic	S920	F.41	F.60
Terrazzo/Marble	Approved Acrylic	S920	F.41	F.60
Raised Access Panel	Approved Acrylic	S920	F.41	F.60

3.4 Raised Access Flooring (see Figure 11)

When using Tackifier special care should be taken as follows:

- Over-application must be avoided to ensure there is no penetration between panels which may bond them together.
- Under no circumstances should tackifier be diluted or poured directly onto panels.
- Tackifier should be applied using a roller to give even coverage.
- Tackifier must be allowed to dry completely before installation of carpet tiles.

NB: Alternatively TacTiles or an approved double-sided tape could be used.

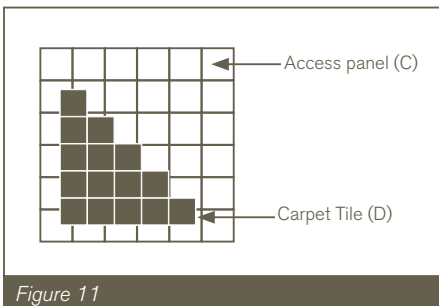

Figure 11

3.5 Perimeter Fixing

The whole tile closest to the wall and all perimeter cuts should be held by TacTiles or laid onto tackifier adhesive or tape. (see Figure 12). In an open perimeter design, a fixed reducer strip anchored to the floor is necessary to lock the tiled area into place.

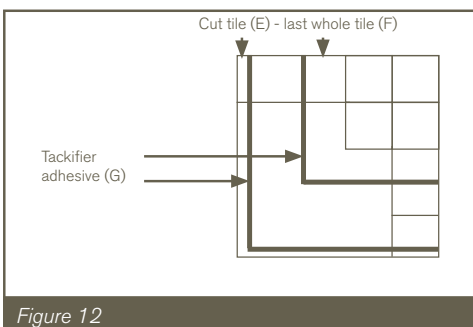

Figure 12

Carpet Tile Installation

4.1 Method

From the starting point, install one row of tiles accurately and firmly along each of the chalk lines. (see Figure 13).

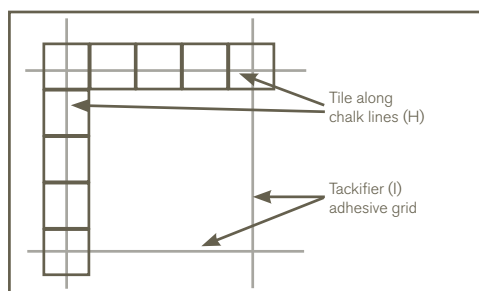

Figure 13

Additional Information – Rugs

Simply follow the design plan and join tiles together using TacTiles to create the desired rug.

4.2 Pile Direction

The back of all Interface products carries arrows denoting pile direction that are important during installation. Product-specific installation recommendations can be found on the shade cards, specifications and in the product catalogue on the website.

There are various methods of tile installation:

Non-directional, Monolithic, Quarter-turn, Brick, Ashlar and Duolithic. For Skinny Planks, Herringbone is also a possibility.

NB: Products designed for non-directional installation will have arrows on the back of the carpet tiles; these can be ignored during a non-directional installation.

 Ashlar: Arrows should all point in the same direction with the tile bond displaced by half a tile in the direction of the arrow.

 Brick: Arrows should all point in the same direction with the tile bond displaced by half a tile at odds with the direction of the arrow.

 Quarter-turn: Tiles turned 90 degrees to one another with no displacement – also known as Chequerboard.

 Monolithic: Arrows should all point in the same direction with no displacement – also known as Broadloom or Sheet.

 Non-directional: Tiles installed without regard to direction and orientation.

 Duolithic: Tile arrows are pointed in opposite directions, resulting in broadloom installation.

Carpet Tile Installation

25 x 100 cm Skinny Planks



- Half Drop



- Variable Drop

Skiny Planks Ashlar: Arrows should all point in the same direction with the skinny plank bond displaced in the length direction.



Skiny Planks Herringbone: Herringbone is created by laying Skinny Planks in an L pattern.

Additional Information – Rugs

On the back of all Interface products are arrows to denote pile direction. For rug designs the direction of these arrows will need to be observed to create the correct pattern effect as per the design plan.

4.3 Alignment

As tiles are butted against each other, frequently check the joints with your fingers to ensure they are properly aligned.

4.4 Tightness

Particular care should be taken at all stages of installation to ensure that the tiles are tightly butted together, with the backing of adjacent tiles touching. The face pile should be brushed back, placed on the floor and pulled in to touch the adjoining tiles, avoiding any pile being caught in the joint (see *Figure 14*).

Loose joints will result in movement and poor floor performance. Avoid too much pressure on adjoining tiles as this will cause them to 'peak' or 'buckle'.



Figure 14

4.5 Complete Each Grid (see *Figure 15*).

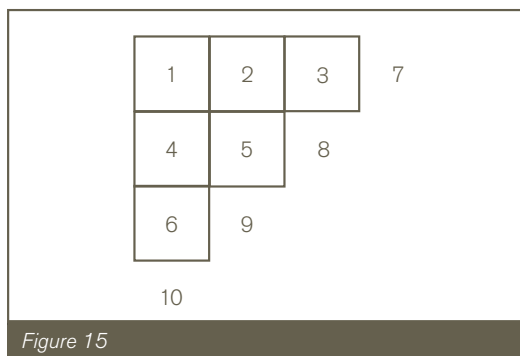

Figure 15

4.6 Cutting

4.6.1 At Perimeters

With the tile face side down, accurately measure and mark the tile on the backing (see *Figure 16*). Using a carpet knife and straight edge, cut through the backing.

NB: Tiles can also be top cut.

Carpet Tile Installation

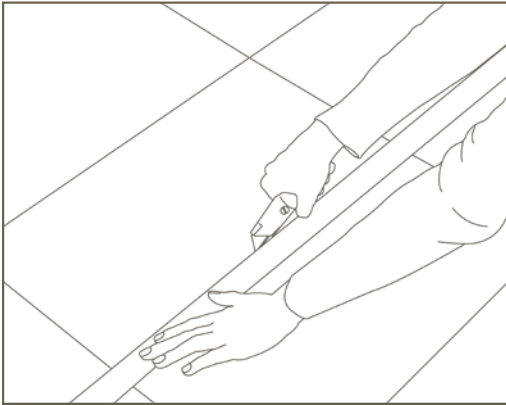

Figure 16

4.6.2
Fit the perimeter cut with its manufactured edge adjoining the last complete tile, then cut the edge to the perimeter.

4.7 Stairways and Vertical Surfaces

4.7.1
Interface carpet tiles can be installed on stairways providing a suitable nosing is fitted.

4.7.2
Tiles fitted to treads and risers of stairs, and all other vertical surfaces, must be secured with an approved adhesive used in accordance with the manufacturer's instructions.

NB: TacTiles are not suitable for stairs

4.7.3
Consideration for neat and tight fitting around mat wells and expansion joints should be given. Under no circumstances should expansion joints be filled with screed and the floor covering taken across.

Additional Information – Rugs

Interface rugs are designed for use beneath furniture in areas such as hotel lounges, bedrooms etc. The described method of installation is suitable for normal applications but for any heavier use areas it may be advisable to look at alternative installation methods which may involve edging strips and/or double-sided tape. In such cases please contact the Interface technical department for further information.

Please note that installations involving TacTiles are not suitable for areas where there are heavy rolling loads.

5. Completion

Until the area is completed, with all perimeter tiles in position, walking upon and/or movement of furniture on the installation should be avoided. Heavy furniture or wheeled traffic can dislodge the carpet tiles under certain conditions. To avoid this during the movement and placement of heavy items, sheets of plywood or hardboard should be laid over the carpet.

Additional Information – Rugs

Until the rug is completed, with all perimeter tiles anchored in position, walking upon and/or movement of furniture on the installation should be avoided. Heavy furniture or wheeled traffic can dislodge carpet tiles under certain conditions.

Skinny Plank Installation

25 x 100 cm Skinny Planks

Skinny Planks can be installed either ashlar or herringbone. Check product specific installation recommendations. For ashlar the same planning and installation practices apply as for standard sized carpet tiles.

6.1 Skinny Planks Ashlar:



Arrows should all point in the same direction with the skinny plank bond displaced in the length direction. Ashlar installation can be done with a half drop or with a variable drop. Both can be used for Interface Skinny Planks, with Ashlar as recommended installation method.

6.2 Skinny Planks Herringbone:



A herringbone pattern can be created in two ways, which requires different levels of planning. Herringbone is created by laying the Skinny Planks in an L pattern. The starting point can be at a 90 degree angle (type A) or a 45 degree angle (type B).

For type A the Skinny Planks can be laid into the right angle created by the chalk lines as described in section 3.2. When building out from these anchor Skinny Planks in an L pattern frequently use the set square to ensure precise alignment and squareness. (See Figure: 17).

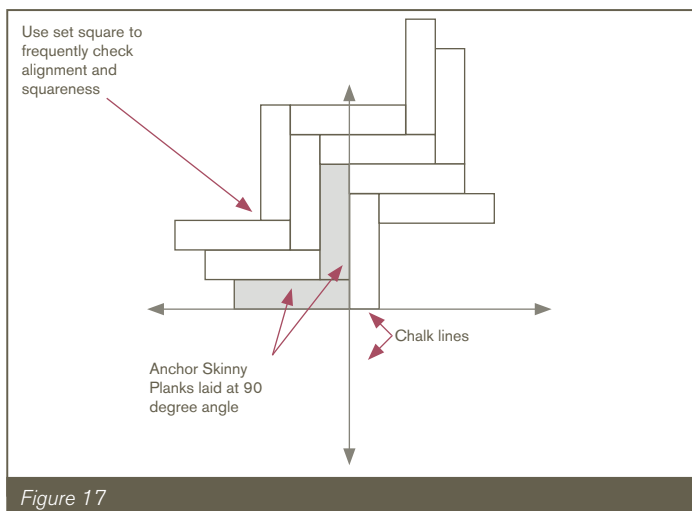

Type B is more complex and requires additional, diagonal working lines. Establish the centre focal point for the desired pattern and snap the centre and base chalk lines as described in section 3.2. Use the set square to check the chalk lines are perpendicular.

The centre line follows the direction of the pattern and to ensure the pattern remains central it may be necessary to measure and draw a working line parallel to the centre line. For skinny planks measure 18 cm and snap a chalk line parallel to the centre line. This is the line to begin laying to.

Dissect the right angles where the working line and baseline meets and chalk diagonal, 45 degree lines. Use the set square to ensure these lines are square and then lay the first plank along the diagonal line, starting at the intersection of the working line and baseline.

Skinny Plank Installation

Place the next plank to create the L shaped pattern and using the set square ensure precise alignment. These two anchor Skinny Planks determine the squareness of the entire installation. Continue with this pattern frequently using the set square to ensure precise alignment. (See Figure: 18).

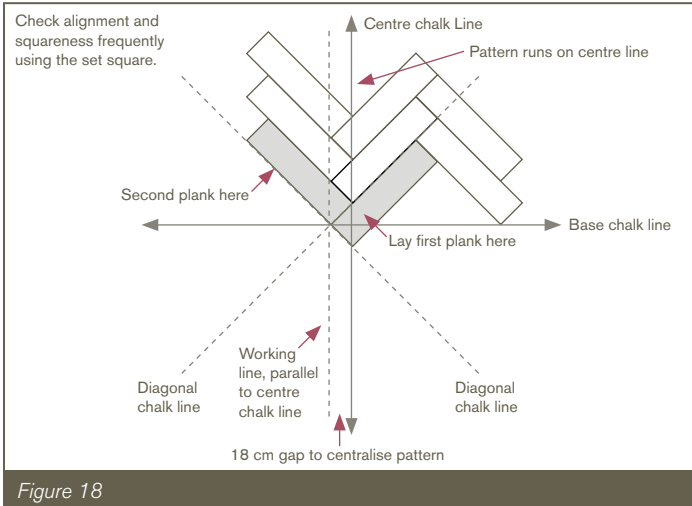

Skinny planks can be fixed using either TacTiles or Tackifier. When using TacTiles the connectors should be placed based on figures 19 & 20:

NB: Heavy foot traffic may require a higher application rate.

Skinny Planks – Herringbone

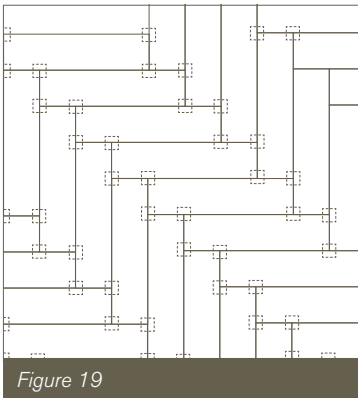

Skinny Planks – Ashlar

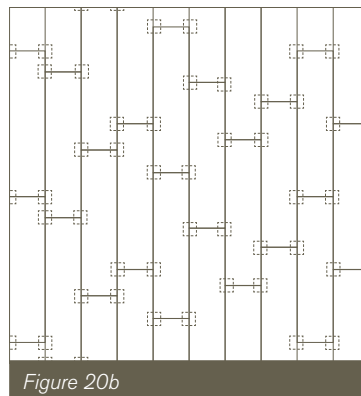
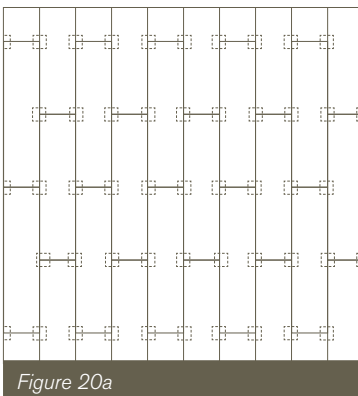

Acoustic & Comfort backing

11 Installation recommendations for Acoustic & Comfort Backing options

11.1 SONE®

SONE is an integrated acoustic backing available for an extensive selection of modular carpet ranges. Designed with the user in mind, SONE enhances both acoustics and underfoot comfort.

When installing products on SONE the same recommendations apply as for carpet tiles on standard backing ([see page 4-12](#)). The method of fixing should be tackifier release adhesive only and not TacTiles. If in doubt please contact the Interface technical department.

When using tackifier an overall application is required.

11.2 ReCushionbac®

ReCushionbac is designed to improve both acoustics and underfoot comfort. It is an integrated backing and is available on many modular carpet ranges.

For installation please follow the same instructions as for carpet tiles on standard backing ([see page 4-12](#)). The method of fixing could be either a tackifier release adhesive or TacTiles.

Interlay

12 Interlay

Interlay is a loose-lay resilient underfloor in 50 x 50 cm tiles. It is designed specifically for Interface modular carpets to improve acoustics and underfoot comfort. When installing Interlay please follow the instructions detailed below:

12.1 Conditioning Of Materials

Due to the nature of modular flooring, the materials need to be acclimatised to the atmospheric conditions that will prevail after installation and during use. Interlay from Interface should be unpacked and allowed to condition in an area having a minimum temperature of 16°C for at least 24 hours before laying.

12.2 Site Conditions

Subfloor preparation requirements and suitability of a subfloor type are the same as for carpet tiles, please see [page 4](#) section 2.1 to 2.3.7 for recommendations

NB: Interlay is not suitable for use over underfloor heating systems

13 Interlay Planning

13.1 Tools

Use steel measuring tape, carpet knife and a straight edge.

13.2 Measurement

Interlay will need to be installed in to a right angle and along a straight wall.

Unlike carpet tiles, installation of Interlay should begin at a straight wall, so choose a straight wall to begin installation.

If no straight wall can be found, create a straight line and right angle with Interlay tiles, anchored by either a piece of double-sided tape or held together by a few TacTiles.

13.3 Method of Fixing

Interlay tiles are loose-laid, do not need tackifier or TacTiles and can be installed at random, with the product coding facing up.

14 Interlay Installation

14.1 Method

Choose a straight wall and install one row of tiles accurately and firmly along this wall.

Build from there and complete using standard tile laying techniques.

14.2 Laying Direction

There is no defined laying direction for Interlay. There are no directional markings to follow and Interlay can be installed randomly with the product coding facing up.

Interlay

14.3 Tightness

Care should be taken at all stages of installation to ensure that the tiles are tightly butted together, with the backing of adjacent tiles touching.

14.4 Cutting

Accurately measure and mark the tile and using a carpet knife and straight edge, you can cut through the material on either side of the tile. Please make sure you make use of sharp carpet knives and firmly cut through the Interlay.

Fit the perimeter cut with its manufactured edge adjoining the last complete tile, then the cut edge to the perimeter.

14.5 Stairways, Vertical Surfaces and Heavy Wheeled Traffic

Interface Interlay is not suitable for installation on stairways, vertical surfaces or in spaces with heavy wheeled traffic.

14.6 Floor height

Interlay adds 6 mm. to the height of the carpet tile floor, so this should be taken into account when assessing door heights etc.

15 Installation of Carpet Tiles on Interlay

15.1 Interface carpet tiles

Once the entire area has been fitted with Interlay it is then time to install the Interface carpet tiles on top.

Follow the standard tile laying methods, as described earlier ([page 6](#)), to determine the centre of the room and the starting point. From here install a row of tiles accurately and firmly along each of the chalk lines and build from there.

15.2 TacTiles

Interface carpet tiles should be installed on top of Interlay using TacTiles or tackifier.

NB: In areas where there is castor chair usage or very heavy foot traffic we would recommend the use of an adhesive to bond the carpet tile to the Interlay. Once the Interlay has been installed then cover with F.40 (high tack dual bond adhesive from F.Ball & Company) or equivalent product (such as Uzin 2100). The F.40 should be trowel applied with a 1.5 mm x 5 mm trowel notch on to the Interlay and left to dry to form a clear, tacky film. Please note that drying times will vary according to temperature, humidity etc and this may need to be left for 2 - 3 hours to properly dry. Laying in to this whilst still wet should be avoided as this would create a permanent bond. Once the F.40 has dried then lay the carpet tiles to complete the installation.

Please note that the carpet tiles should overlap the Interlay tiles as the system is not designed to sit in register with the carpet tiles.

15.3 Interface skinny planks

Skinny planks can be installed over Interlay if laid ashlar. Skinny planks laid herringbone are not recommended over Interlay.

Interlay

16 Interlay Completion

Until the area is completed, with all perimeter tiles in position, walking upon and/or movement of furniture on the installation should be avoided. Also heavy point loads should be avoided on the installation of Interlay with Interface carpet tiles.

Heavy furniture or wheeled traffic can dislodge the carpet tiles on top of Interlay under certain conditions which may cause a trip hazard.

To avoid this during the movement and placement of heavy items, sheets of plywood or hardboard should be laid over the carpet.

17 Interlay Warnings

1. Any variation in site practices to the above may have the effect of rendering the guarantee invalid. Interface cannot accept responsibility for faults occurring as a result of methods of installation varying from those outlined above. These instructions should also be read in conjunction with the Interface conditions of sale.
2. Interlay can be used in conjunction with all standard Interface carpet tile products except for Microtuft or PVC backed products. For low level loop pile products the maximum installation size is 300m².
3. The combination of Interlay and Interface carpet tiles installed with TacTiles is not recommended for installation in spaces with heavy rolling loads or over existing carpet surfaces.

Queries

For further information
please contact the
Technical Department on
01274 690690 or visit:

www.interface.com

[↑ Back to Contents](#)



Climate change is undeniable. And reversible. Our mission is to prove it. Join the #ClimateTakeBack and help create a climate fit for life.